

**HORIZON**<sup>®</sup>  
H O B B Y

**Eflite**<sup>®</sup>  
ADVANCING ELECTRIC FLIGHT

# UMX<sup>™</sup> A-10

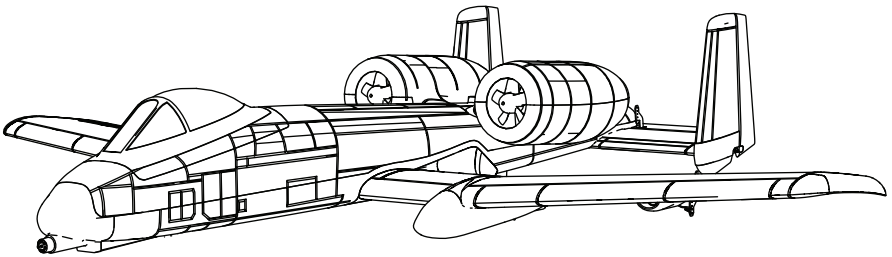

*Instruction Manual  
Bedienungsanleitung  
Manuel d'utilisation  
Manuale di Istruzioni*

**AS3X**<sup>®</sup>

**Bind-N-Fly**<sup>®</sup>  
BASIC

**NOTICE**

All instructions, warranties and other collateral documents are subject to change at the sole discretion of Horizon Hobby, LLC. For up-to-date product literature, visit [www.horizonhobby.com](http://www.horizonhobby.com) and click on the support tab for this product.

**Meaning of Special Language:**

The following terms are used throughout the product literature to indicate various levels of potential harm when operating this product:

**NOTICE:** Procedures, which if not properly followed, create a possibility of physical property damage AND little or no possibility of injury.

**CAUTION:** Procedures, which if not properly followed, create the probability of physical property damage AND a possibility of serious injury.

**WARNING:** Procedures, which if not properly followed, create the probability of property damage, collateral damage, and serious injury OR create a high probability of superficial injury.

 **WARNING:** Read the ENTIRE instruction manual to become familiar with the features of the product before operating. Failure to operate the product correctly can result in damage to the product, personal property and cause serious injury.

This is a sophisticated hobby product. It must be operated with caution and common sense and requires some basic mechanical ability. Failure to operate this product in a safe and responsible manner could result in injury or damage to the product or other property. This product is not intended for use by children without direct adult supervision. Do not use with incompatible components or alter this product in any way outside of the instructions provided by Horizon Hobby, LLC. This manual contains instructions for safety, operation and maintenance. It is essential to read and follow all the instructions and warnings in the manual, prior to assembly, setup or use, in order to operate correctly and avoid damage or serious injury.

**Age Recommendation: Not for children under 14 years. This is not a toy.**

**Safety Precautions and Warnings**

- Always keep a safe distance in all directions around your model to avoid collisions or injury. This model is controlled by a radio signal subject to interference from many sources outside your control. Interference can cause momentary loss of control.
- Always operate your model in open spaces away from full-size vehicles, traffic and people.
- Always carefully follow the directions and warnings for this and any optional support equipment (chargers, rechargeable battery packs, etc.).
- Always keep all chemicals, small parts and anything electrical out of the reach of children.
- Always avoid water exposure to all equipment not specifically designed and protected for this purpose. Moisture causes damage to electronics.
- Never place any portion of the model in your mouth as it could cause serious injury or even death.
- Never operate your model with low transmitter batteries.
- Always keep aircraft in sight and under control.
- Always use fully charged batteries.
- Always keep the transmitter powered on while aircraft is powered.
- Always remove batteries before disassembly.
- Always keep moving parts clean.
- Always keep parts dry.
- Always let parts cool after use before touching.
- Always remove batteries after use.
- Always ensure failsafe is properly set before flying.
- Never operate aircraft with damaged wiring.
- Never touch moving parts.

## Table of Contents

Transmitter and Receiver Binding.....	4	Post Flight Checklist .....	12
Low Voltage Cutoff (LVC) .....	4	Troubleshooting Guide .....	12
ESC/Receiver Arming, Battery Installation and Center of Gravity .....	5	Troubleshooting Guide (Continued).....	13
Control Centering .....	6	Limited Warranty .....	13
Factory Control Horn Settings.....	6	Warranty and Service Contact Information .....	15
Dual Rates and Expos .....	6	IC Information .....	15
Landing Gear Removal.....	7	FCC Information.....	15
Control Direction Test.....	8	Compliance Information for the European Union..	16
AS3X Direction Test.....	9	Replacement Parts.....	59
Flying Tips and Repairs.....	10	Optional Parts and Accessories .....	60
Motor Service .....	11		

## Specifications

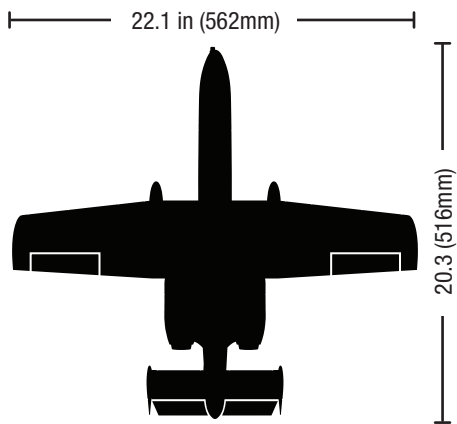

Wing Area: 83.7 sq. in.  
(5.40 dm<sup>2</sup>)





5.9 oz  
(168 g)

## Preflight Checklist

✓	
	1. Charge flight battery.
	2. Install flight battery in aircraft (once it has been fully charged).
	3. Bind aircraft to transmitter.
	4. Make sure linkages move freely.
	5. Perform Control Direction Test with transmitter.
	6. Perform AS3X Control Direction Test with aircraft.

### Installed

 **(2) Motors:** BL180M, 13500Kv inrunner brushless motor

 **Receiver:** DSMX® UM 6-Ch AS3X® w/ Twin Brushless ESC

 (4) 2.3-Gram Performance Linear Long Throw Servo (SPMSA2030L)

### Required to Complete

 **Recommended Battery:** 800mAh 2S 7.4V 30C Li-Po, (EFLB8002SJ30)

 **Battery Charger:** Celectra™ 2S 7.4V DC Li-Po Charger (EFLUC1007)

 **Recommended Transmitter:** Full range Spektrum™ DSM2®/DSMX® with dual-rates (DXe and up)

✓	
	7. Set dual rates.
	8. Adjust center of gravity.
	9. Perform a radio system Range Check.
	10. Find a safe and open area.
	11. Plan flight for flying field conditions.
	12. Set flight timer for 5 minutes for first flight.

## Transmitter and Receiver Binding

For a list of compatible DSM2/DSMX transmitters, please visit [www.bindnfly.com](http://www.bindnfly.com)

### ✓ Binding Procedure

**⚠ CAUTION:** When using a Futaba transmitter with a Spektrum DSM® module, you must reverse the throttle channel and rebind. Refer to your Spektrum module manual for binding and failsafe instructions. Refer to your Futaba transmitter manual for instructions on reversing the throttle channel.

1.	Refer to your transmitter's unique instructions for binding to a receiver (location of transmitter's Bind control).
2.	Make sure the flight battery is disconnected from the aircraft.
3.	Ensure the transmitter is powered OFF.
4.	Connect the flight battery to the aircraft and turn the aircraft upright. The receiver LED will begin to flash (typically after 5 seconds).
5.	Ensure that control surface trims are centered and the throttle and throttle trims are in the low position to correctly set the failsafe.
6.	Put your transmitter into bind mode. Refer to your transmitter's manual for binding button or switch instructions.
7.	After 5 to 10 seconds, the receiver status LED will turn solid, indicating that the receiver is bound to the transmitter. If the LED does not turn solid, refer to the Troubleshooting Guide at the back of the manual.

For subsequent flights, power ON the transmitter for 5 seconds before connecting the flight battery.

## Low Voltage Cutoff (LVC)

When a Li-Po battery is discharged below 3V per cell, it will not hold a charge. The aircraft's ESC protects the flight battery from over-discharge using Low Voltage Cutoff (LVC). Once the battery discharges to 3V per cell, the LVC will reduce the power to the motor in order to leave adequate power to the receiver and servos to land the aircraft.

When the motor power decreases, land the aircraft immediately and replace or recharge the flight battery.

Always disconnect and remove the Li-Po battery from the aircraft after each flight. Charge your Li-Po battery to about half capacity before storage. Make sure the battery charge does not fall below 3V per cell. Failure to unplug a connected battery will result in trickle discharge.

**For your first flights, set your transmitter timer or a stopwatch to 5 minutes.** Adjust your timer for longer or shorter flights once you have flown the model.

**NOTICE:** Repeated flying to LVC will damage the battery.

# ESC/Receiver Arming, Battery Installation and Center of Gravity

**NOTICE:** Always keep material or debris away from the intake. When armed, the rotor will turn in response to throttle movement and could ingest in any loose objects.

Arming the ESC/receiver also occurs after binding as previously described, but subsequent connection of a flight battery requires the following steps.

1. Lower the throttle and throttle trim to the lowest settings on your transmitter.
2. Remove the battery/canopy hatch from the fuselage and install a flight battery (A) all the way to the back of the battery compartment.

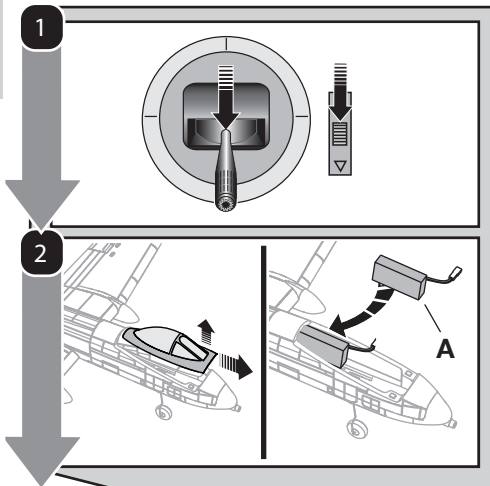

## Center of Gravity (CG)

The CG location is **34-36mm** back from the leading edge of the wing at the root. Balance the airplane inverted on this recommended CG mark with all landing gear installed. Adjust as needed by sliding the battery forward or back.

3. Power on your transmitter, then wait 5 seconds.
4. Connect the battery to the ESC, noting proper polarity. **Keep the plane immobile and away from wind for 5 seconds to allow the AS3X system to initialize.**

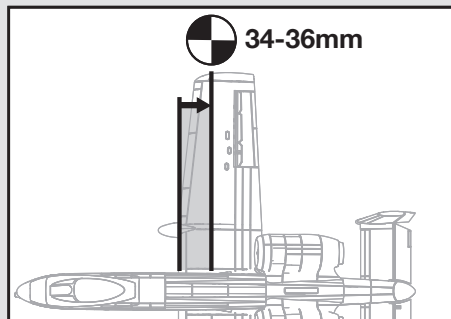

A successful connection is indicated by:

- A series of tones
- A continuous LED

**CAUTION:** Always disconnect the Li-Po battery from the ESC when not flying to eliminate power supplied to the motor. The ESC does not have an arming switch and will respond to any transmitter input when a signal is present.

**CAUTION:** Always disconnect the Li-Po battery from the ESC when not flying to avoid over-discharging the battery. Batteries discharged to a voltage lower than the lowest approved voltage may become damaged, resulting in loss of performance and potential fire when batteries are charged.

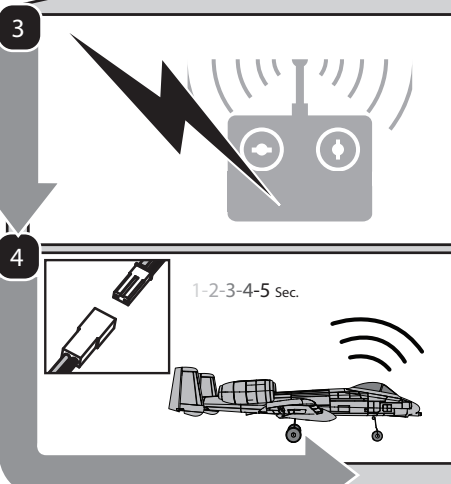

## Control Centering

Before the first flights, or in the event of an accident, make sure control surfaces are centered when the transmitter controls and trims are neutral. The transmitter sub-trim must be set to zero. Adjust the linkages mechanically if the control surfaces are not centered. Use of the transmitter sub-trims may not correctly center the aircraft control surfaces due to the mechanical limits of linear servos.

- Make the U-shape narrower to make the connector shorter. Make the U-shape wider to make the linkage longer.
- Ensure that the leading edge of both the horizontal stabilizers are 1mm above the lower edge of the side panel, as shown in the image to the right.

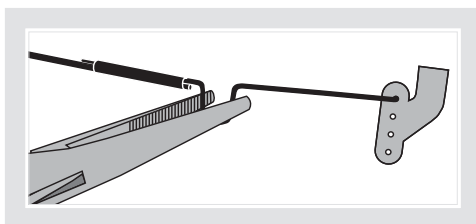

## Factory Control Horn Settings

The illustration shows the factory settings for linkages on the control horns. Linkage connections on the control horns directly affect aircraft response.

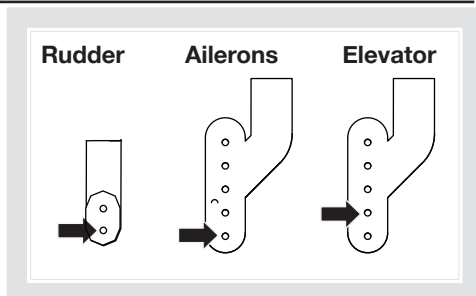

## Dual Rates and Expos

To obtain the best flight performance, we recommend using a DSM2/DSMX transmitter capable of Dual Rates and Expo. Before binding, ensure that you are starting with a blank acro model in your transmitter. **Set wing type and servo reversing to normal.**

The suggested settings shown here are the recommended starting settings. Adjust according to the individual preferences after the initial flight.

**NOTICE: Do not set your transmitter travel adjust over 100%.** If the TRAVEL ADJUST is set over 100%, it will not result in more control movement, it will overdrive the servo and cause damage.

It is normal for linear servos to make significant noise. The noise is not an indication of a faulty servo.

	Dual Rates		Expos	
	High	Low	High	Low
Aileron	100%	70%	10%	0%
Elevator	100%	70%	10%	0%
Rudder	100%	70%	10%	0%

**Tip:** For landing, we recommend using high rate elevator.

# Landing Gear Removal

1. Carefully pull the gear straight out of the retainer clip that secures it into the fuselage.

When needed, assemble in reverse order.

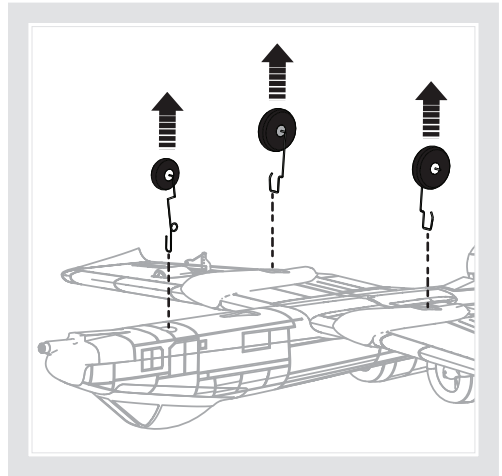

When the landing gear is reinstalled, make sure the nose gear is angled forward as shown.

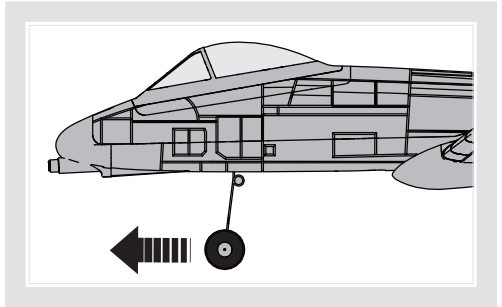



## Control Direction Test

You should bind your aircraft and transmitter before doing these tests.

Move the controls on the transmitter to make sure the aircraft control surfaces move correctly and in the proper direction.

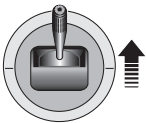
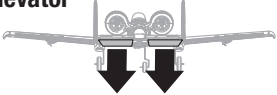
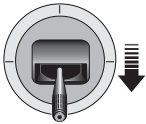
Make sure the tail linkages move freely and that paint or decals are not adhered to them.

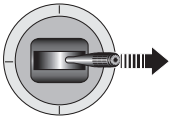
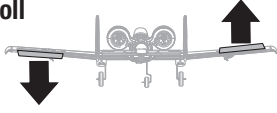
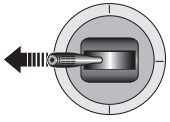
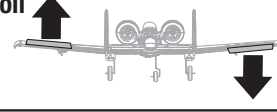
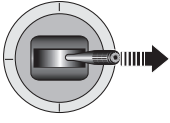
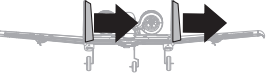
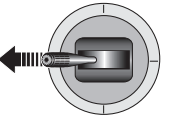
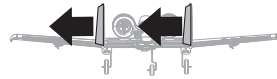
	Transmitter Command	Aircraft Reaction
Elevator		<b>Down Elevator</b> 
		<b>Up Elevator</b> 
Aileron		<b>Right Roll</b> 
		<b>Left Roll</b> 
Rudder		<b>Right Rudder</b> 
		<b>Left Rudder</b> 

Arrows indicate the direction of the trailing edge of the control surface.







## AS3X Direction Test

You should bind your aircraft and transmitter before doing these tests.

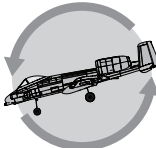
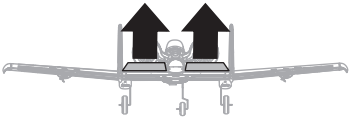
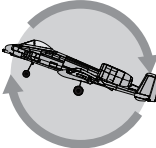
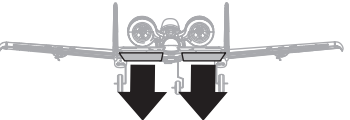
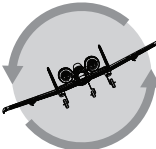
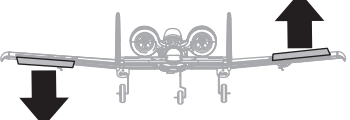
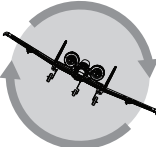
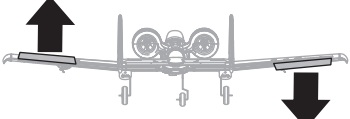
Move the controls on the transmitter to make sure the aircraft control surfaces move correctly and in the proper direction.

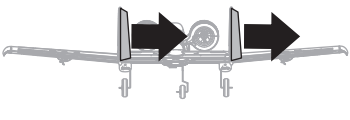
Make sure the tail linkages move freely and that paint or decals are not adhered to them.

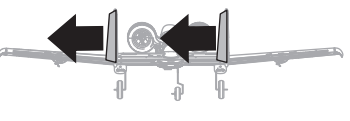
Aircraft movement	AS3X Reaction
	
	
	
	
	
	

Arrows indicate the direction of the trailing edge of the control surface.

# Flying Tips and Repairs

## Range Check your Radio System

After final assembly, range check the radio system with the aircraft. Refer to your specific transmitter instruction manual for range test information.

## Flying

We recommend flying your aircraft outside in no greater than moderate winds or inside in a very large indoor facility. Always avoid flying near houses, trees, wires and buildings. Be careful to avoid flying in areas where there are many people, such as busy parks, schoolyards or soccer fields. Consult local laws and ordinances before choosing a location to fly your aircraft.

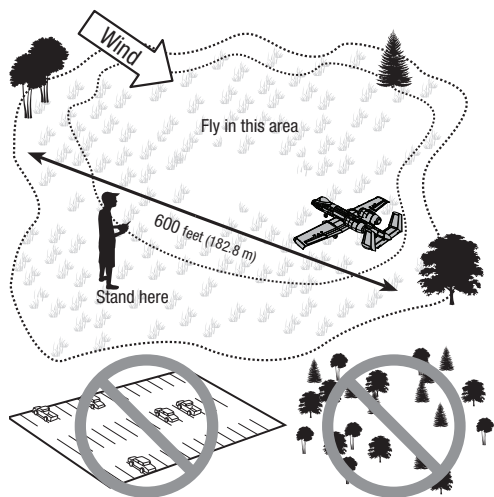

## Hand Launching

Hold the aircraft just behind the wings. Apply full throttle with a little up elevator and give a firm toss directly into the wind with the nose pointed slightly up (5–10 degrees above the horizon). After the model gains altitude, decrease the throttle as you desire.

The A-10 has a high thrust line. If the model is not launched with enough airspeed or the throttle is added quickly at very low airspeed the aircraft will pitch down slightly. Adding some up elevator trim for the first few hand launches is recommended, until you are comfortable with the launching characteristics of this aircraft.

**Tip:** The electric ducted fans (EDF) acts like a jet aircraft, so control is generated by airspeed rather than air from a propeller moving over the control surfaces.

## Takeoff

Taxi the aircraft in position for takeoff (facing into the wind if flying outdoors). Gradually increase the throttle to full power, holding a small amount of up elevator and steering with the rudder. Climb gently to check trim. Once the trim is adjusted, begin exploring the flight envelope of the aircraft.

## Landing

Always land into the wind. Fly the landing pattern with a slightly nose high attitude. Use throttle management to control the decent rate of the aircraft.

During flare, keep the wings level and the airplane pointed into the wind. Gently lower the throttle while pulling back on the elevator to bring the aircraft down on the main wheels or to belly land without landing gear.

**NOTICE:** Always fully lower the throttle when landing the aircraft to prevent intake of foreign objects, which can damage the ducted fan and motor.

Failure to lower the throttle stick and trim to the lowest possible positions during a crash could result in damage to the ESC in the receiver unit, which may require replacement.

## Over Current Protection (OCP)

The aircraft is equipped with Over Current Protection. OCP protects the ESC from overheating and stops the motor when the transmitter throttle is set too high and the rotor cannot turn. OCP will only activate when the throttle is positioned just above 1/2 throttle. After the ESC stops the motor, fully lower the throttle to re-arm the ESC.

# Motor Service

## Disassembly

**⚠ CAUTION:** DO NOT handle the rotor or motor while the flight battery is connected. Personal injury could result.

1. The lower half of the nacelle hatch is secured to the top half using glue and clear tape. Carefully cut the clear tape and follow the seam with a knife to cut the glue and remove the bottom half of the nacelle.

**NOTICE:** Removing tape or decals can damage paint on your aircraft. Avoid pinching or otherwise damaging any wires when opening or closing the fuselage.

2. Disconnect the motor from the receiver.
3. Carefully remove the lower half of the nacelle (A) from the upper half of the nacelle.
4. Remove the 4 screws (B) and fan unit (C) from the upper nacelle half.
5. Put a small flat blade screwdriver in the motor mount hole (D) and carefully push the rotor (E) away from the motor shaft (F) to avoid bending the motor shaft.
6. Remove the 4 screws (G) and motor from the motor mount.

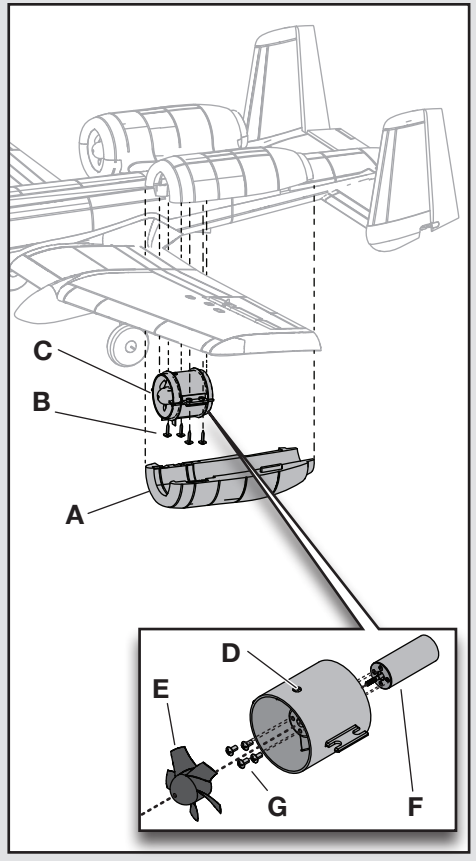
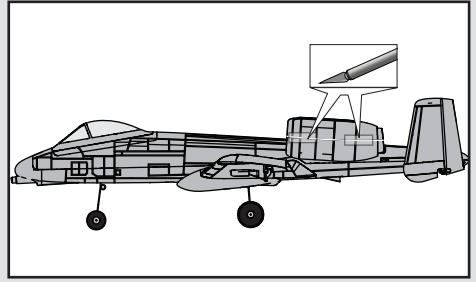

## Assembly

- Assemble in reverse order, connecting the top and bottom half of the nacelle with clear tape and or foam safe CA.

**NOTICE:** Always install the motor mount so that the rotor faces the front of the fuselage and the hole in the unit faces the bottom of the fuselage.

## Post Flight Checklist

✓	
1.	Disconnect the flight battery from the ESC (Required for safety and battery life).
2.	Power OFF the transmitter.
3.	Remove the flight battery from the aircraft.
4.	Recharge the flight battery.

✓	
5.	Store the flight battery apart from the aircraft and monitor the battery charge.
6.	Make note of the flight conditions and flight plan results, planning for future flights.

## Troubleshooting Guide

AS3X		
Problem	Possible Cause	Solution
Control surfaces not at neutral position when transmitter controls are at neutral	Control surfaces may not have been mechanically centered from factory	Center control surfaces mechanically by adjusting the U-bends on control linkages
	Aircraft was moved after the flight battery was connected and before sensors initialized	Disconnect and reconnect the flight battery while keeping the aircraft still for 5 seconds
Model flies inconsistently from flight to flight	Aircraft was not kept immobile for 5 seconds after battery was plugged in	Keep the aircraft immobile for 5 seconds after plugging in the battery
	Trims are moved too far from neutral position	Neutralize trims and mechanically adjust linkages to center control surfaces
Controls oscillate in flight, (model rapidly jumps or moves)	Rotor is unbalanced, causing excessive vibration	Remove rotor and motor. Check motor shaft for straightness and replace rotor if damaged

Problem	Possible Cause	Solution
Aircraft will not respond to throttle but responds to other controls	Throttle stick and/or throttle trim too high	Reset controls with throttle stick and throttle trim at lowest setting
	Throttle channel is reversed	Reverse throttle channel on transmitter
	Motor disconnected from receiver	Open fuselage and make sure motor is connected to the receiver
	Flight battery charge is low	Fully recharge flight battery
Extra motor noise or extra vibration	Damaged rotor or motor	Replace damaged parts
	Rotor out of balance	Balance or replace the rotor
Reduced flight time or aircraft underpowered	Flight battery charge is low	Completely recharge flight battery
	Flight battery damaged	Replace flight battery and follow flight battery instructions
	Flight conditions may be too cold	Make sure battery is warm before use
	Battery capacity too low for flight conditions	Replace battery or use a larger capacity battery
LED on receiver flashes and aircraft will not bind to transmitter (during binding)	Transmitter too near aircraft during binding process	Power off transmitter, move transmitter a larger distance from aircraft, disconnect and reconnect flight battery to aircraft and follow binding instructions
	Bind switch or button not held long enough during bind process	Power off transmitter and repeat bind process. Hold transmitter bind button or switch until receiver is bound
	Aircraft or transmitter is too close to large metal object, wireless source or another transmitter	Move aircraft and transmitter to another location and attempt binding again

## Troubleshooting Guide (Continued)

Problem	Possible Cause	Solution
LED on receiver flashes rapidly and aircraft will not respond to transmitter (after binding)	Less than a 5-second wait between first powering on transmitter and connecting flight battery to aircraft	Leaving transmitter on, disconnect and reconnect flight battery to aircraft
	Aircraft bound to different model memory (ModelMatch™ radios only)	Select correct model memory on transmitter and disconnect and reconnect flight battery to aircraft
	Flight battery/transmitter battery charge is too low	Replace/recharge batteries
	Transmitter may have been bound to a different model (or with a different DSM Protocol)	Select the right transmitter or bind to the new one
	Aircraft or transmitter is too close to large metal object, wireless source or another transmitter	Move aircraft and transmitter to another location and attempt linking again
Control surface does not move	Control surface, control horn, linkage or servo damage	Replace or repair damaged parts and adjust controls
	Wire damaged or connections loose	Do a check of wires and connections, connect or replace as needed
	Flight battery charge is low	Fully recharge flight battery
	Control linkage does not move freely	Make sure control linkage moves freely
Controls reversed	Transmitter settings reversed	Adjust controls on transmitter appropriately
Motor loses power	Damage to motor or power components	Do a check of motor and power components for damage (replace as needed)
Motor power quickly decreases and increases then motor loses power	Battery power is down to the point of receiver/ESC Low Voltage Cutoff (LVC)	Recharge flight battery or replace battery that is no longer performing
Servo locks or freezes at full travel	Travel adjust value is set above 100%, overdriving the servo	Set Travel adjust to 100% or less and/or set sub-trims to Zero and adjust linkages mechanically

## Limited Warranty

### What this Warranty Covers

Horizon Hobby, LLC, (Horizon) warrants to the original purchaser that the product purchased (the "Product") will be free from defects in materials and workmanship at the date of purchase.

### What is Not Covered

This warranty is not transferable and does not cover (i) cosmetic damage, (ii) damage due to acts of God, accident, misuse, abuse, negligence, commercial use, or due to improper use, installation, operation or maintenance, (iii) modification of or to any part of the Product, (iv) attempted service by anyone other than a Horizon Hobby authorized service center, (v) Product not purchased from an authorized Horizon dealer, or (vi) Product not compliant with applicable technical regulations, or (vii) use that violates any applicable laws, rules, or regulations.

OTHER THAN THE EXPRESS WARRANTY ABOVE, HORIZON MAKES NO OTHER WARRANTY OR REPRESENTATION, AND HEREBY DISCLAIMS ANY AND ALL IMPLIED WARRANTIES, INCLUDING, WITHOUT LIMITATION, THE IMPLIED WARRANTIES OF NON-INFRINGEMENT, MERCHANTABILITY AND FITNESS FOR A PARTICULAR PURPOSE. THE PURCHASER ACKNOWLEDGES THAT THEY ALONE HAVE DETERMINED THAT THE PRODUCT WILL SUITABLY MEET THE REQUIREMENTS OF THE PURCHASER'S INTENDED USE.

### Purchaser's Remedy

Horizon's sole obligation and purchaser's sole and exclusive remedy shall be that Horizon will, at its option, either (i) service, or (ii) replace, any Product determined by Horizon to be defective.

Horizon reserves the right to inspect any and all Product(s) involved in a warranty claim. Service or replacement decisions are at the sole discretion of Horizon. Proof of purchase is required for all warranty claims. **SERVICE OR REPLACEMENT AS PROVIDED UNDER THIS WARRANTY IS THE PURCHASER'S SOLE AND EXCLUSIVE REMEDY.**

#### **Limitation of Liability**

HORIZON SHALL NOT BE LIABLE FOR SPECIAL, INDIRECT, INCIDENTAL OR CONSEQUENTIAL DAMAGES, LOSS OF PROFITS OR PRODUCTION OR COMMERCIAL LOSS IN ANY WAY, REGARDLESS OF WHETHER SUCH CLAIM IS BASED IN CONTRACT, WARRANTY, TORT, NEGLIGENCE, STRICT LIABILITY OR ANY OTHER THEORY OF LIABILITY, EVEN IF HORIZON HAS BEEN ADVISED OF THE POSSIBILITY OF SUCH DAMAGES. Further, in no event shall the liability of Horizon exceed the individual price of the Product on which liability is asserted. As Horizon has no control over use, setup, final assembly, modification or misuse, no liability shall be assumed nor accepted for any resulting damage or injury. By the act of use, setup or assembly, the user accepts all resulting liability. If you as the purchaser or user are not prepared to accept the liability associated with the use of the Product, purchaser is advised to return the Product immediately in new and unused condition to the place of purchase.

#### **Law**

These terms are governed by Illinois law (without regard to conflict of law principals). This warranty gives you specific legal rights, and you may also have other rights which vary from state to state. Horizon reserves the right to change or modify this warranty at any time without notice.

#### **WARRANTY SERVICES**

##### **Questions, Assistance, and Services**

Your local hobby store and/or place of purchase cannot provide warranty support or service. Once assembly, setup or use of the Product has been started, you must contact your local distributor or Horizon directly. This will enable Horizon to better answer your questions and service you in the event that you may need any assistance. For questions or assistance, please visit our website at [www.horizonhobby.com](http://www.horizonhobby.com), submit a Product Support Inquiry, or call the toll free telephone number referenced in the Warranty and Service Contact Information section to speak with a Product Support representative.

##### **Inspection or Services**

If this Product needs to be inspected or serviced and is compliant in the country you live and use the Product in, please use the Horizon Online Service Request submission process found on our website or call Horizon to obtain a Return Merchandise Authorization (RMA) number. Pack the Product securely using a shipping carton. Please note that original boxes may be included, but are not designed to withstand the rigors of shipping without additional protection. Ship via a carrier

that provides tracking and insurance for lost or damaged parcels, as Horizon is not responsible for merchandise until it arrives and is accepted at our facility. An Online Service Request is available at [http://www.horizonhobby.com/content/\\_service-center\\_render-service-center](http://www.horizonhobby.com/content/_service-center_render-service-center). If you do not have internet access, please contact Horizon Product Support to obtain a RMA number along with instructions for submitting your product for service. When calling Horizon, you will be asked to provide your complete name, street address, email address and phone number where you can be reached during business hours. When sending product into Horizon, please include your RMA number, a list of the included items, and a brief summary of the problem. A copy of your original sales receipt must be included for warranty consideration. Be sure your name, address, and RMA number are clearly written on the outside of the shipping carton.

**NOTICE: Do not ship LiPo batteries to Horizon. If you have any issue with a LiPo battery, please contact the appropriate Horizon Product Support office.**

#### **Warranty Requirements**

**For Warranty consideration, you must include your original sales receipt verifying the proof-of-purchase date.** Provided warranty conditions have been met, your Product will be serviced or replaced free of charge. Service or replacement decisions are at the sole discretion of Horizon.

#### **Non-Warranty Service**

**Should your service not be covered by warranty, service will be completed and payment will be required without notification or estimate of the expense unless the expense exceeds 50% of the retail purchase cost.** By submitting the item for service you are agreeing to payment of the service without notification. Service estimates are available upon request. You must include this request with your item submitted for service. Non-warranty service estimates will be billed a minimum of ½ hour of labor. In addition you will be billed for return freight. Horizon accepts money orders and cashier's checks, as well as Visa, MasterCard, American Express, and Discover cards. By submitting any item to Horizon for service, you are agreeing to Horizon's Terms and Conditions found on our website [http://www.horizonhobby.com/content/\\_service-center\\_render-service-center](http://www.horizonhobby.com/content/_service-center_render-service-center).

**ATTENTION: Horizon service is limited to product compliant in the country of use and ownership. If received, a non-compliant Product will not be serviced. Further, the sender will be responsible for arranging return shipment of the un-serviced Product, through a carrier of the sender's choice and at the sender's expense. Horizon will hold non-compliant Product for a period of 60 days from notification, after which it will be discarded.**

# Warranty and Service Contact Information

Country of Purchase	Horizon Hobby	Phone Number/Email Address	Address
United States of America	Horizon Service Center (Repairs and Repair Requests)	servicecenter.horizonhobby.com/RequestForm/	4105 Fieldstone Rd Champaign, Illinois, 61822 USA
	Horizon Product Support (Product Technical Assistance)	productsupport@horizonhobby.com 877-504-0233	
	Sales	websales@horizonhobby.com 800-338-4639	
United Kingdom	Service/Parts/Sales: Horizon Hobby Limited	sales@horizonhobby.co.uk +44 (0) 1279 641 097	Units 1–4 , Ployters Rd, Staple Tye Harlow, Essex, CM18 7NS, United Kingdom
Germany	Horizon Technischer Service	service@horizonhobby.de	Christian-Junge-Straße 1 25337 Elmshorn, Germany
	Sales: Horizon Hobby GmbH	+49 (0) 4121 2655 100	
France	Service/Parts/Sales: Horizon Hobby SAS	infofrance@horizonhobby.com +33 (0) 1 60 18 34 90	11 Rue Georges Charpak 77127 Lieusaint, France

## IC Information

### IC ID: 6157A-EFLAS6410NBLT

Under Industry Canada regulations, this radio transmitter may only operate using an antenna of a type and maximum (or lesser) gain approved for the transmitter by Industry Canada. To reduce potential radio interference to other users, the antenna type and its gain should be so chosen that the equivalent isotropically radiated power (e.i.r.p.) is not more than that necessary for successful communication.

This device complies with Industry Canada licence-exempt RSS standard(s). Operation is subject to the following two conditions: (1) this device may not cause interference, and (2) this device must accept any interference, including interference that may cause undesired operation of the device.”

## FCC Information

### FCC ID: BRWEFLAS6410NBLT

This equipment has been tested and found to comply with the limits for Part 15 of the FCC rules. These limits are designed to provide reasonable protection against harmful interference in a residential installation. This equipment generates uses and can radiate radio frequency energy and, if not installed and used in accordance with the instructions, may cause harmful interference to radio communications.

However, there is no guarantee that interference will not occur in a particular installation. If this equipment does cause harmful interference to radio or television reception, which can be determined by turning the equipment off and on, the user is encouraged to try to correct the interference by one or more of the following measures:

- Reorient or relocate the receiving antenna.
- Increase the separation between the equipment and receiver.
- Connect the equipment to an outlet on a circuit different from that to which the receiver is connected.

This device complies with part 15 of the FCC rules. Operation is subject to the following two conditions: (1) This device may not cause harmful interference, and (2) this device must accept any interference received, including interference that may cause undesired operation.

Note: Modifications to this product will void the user's authority to operate this equipment.

## Compliance Information for the European Union



**EFL UMX A-10 BNF Basic (EFLU3750)**

**EU Compliance Statement:** Horizon Hobby, LLC hereby declares that this product is in compliance with the essential requirements and other relevant provisions of the RED Directive.

A copy of the EU Declaration of Conformity is available online at: <http://www.horizonhobby.com/content/support-render-compliance>.

### Instructions for disposal of WEEE by users in the European Union



This product must not be disposed of with other waste. Instead, it is the user's responsibility to dispose of their waste equipment by handing it over to a designated collections point for the recycling of waste electrical and electronic equipment. The separate collection and recycling of your waste equipment at the time of disposal will help to conserve natural resources and ensure that it is recycled in a manner that protects human health and the environment. For more information about where you can drop off your waste equipment for recycling, please contact your local city office, your household waste disposal service or where you purchased the product.



# Replacement Parts – Ersatzteile – Pièces de rechange – Ricambi

Part # • Nummer Numéro • Codice	Description	Beschreibung	Description	Descrizione
EFLAS6410NBLT	DSMX 6-Ch AS3X receiver w/Twin Brushless ESC	DSMX 6-Kanal AS3X Empfänger mit bürstenlosem doppeltem Geschwindigkeitsregler	Récepteur DSMX 6 voies AS3X avec double contrôleur Brushless	Ricevente AS3X a 6 canali DSMX con doppio ESC brushless
EFLDF180M1	Rotor: Delta-V 180m	Rotor: Delta-V 180 m	Delta-V 180m - Rotor pour turbine	Rotore: Delta-V 180m
EFLDF180M2	Delta-V 180m 28mm EDF Unit V2	Delta-V 180 m 28 mm EDF-Einheit V2	Delta-V 180m - Module turbine 28mm EDF V2	Ventola intubata V2 Delta-V 180m 28 mm
EFLM30180MDFC	BL180m Ducted Fan Motor, 13,500Kv, 100mm Wire	BL180m Impeller-Motor, 13.500 Kv, 100 mm Kabel	Moteur BL180M, 13,500Kv pour turbine, câble 100mm	Ventola intubata BL180m con motore, 13.500 Kv, cavo 100 mm
EFLU3701	Main Wing: UMX A-10 BL	Hauptflügel: UMX A-10 BL	UMX A-10 BL - Aile principale	Ala principale: UMX A-10 BL
EFLU3702	Fuselage w/ accessories: UMX A-10 BL	Rumpf mit Zubehör: UMX A-10 BL	UMX A-10 BL - Fuselage avec accessoires	Fusoliera con accessori: UMX A-10 BL
EFLU3703	Engine Nacelle Set w/accessories: UMX A-10 BL	Motorgondelsatz mit Zubehör: UMX A-10 BL	UMX A-10 BL - Nacelle moteur avec accessoires	Gondola motore con accessori: UMX A-10 BL
EFLU3704	Tail Set: UMX A-10 BL	Leitwerksatz: UMX A-10 BL	UMX A-10 BL - Empennage	Piani di coda: UMX A-10 BL
EFLU3705	Landing Gear : UMX A-10 BL	Fahrwerk: UMX A-10 BL	UMX A-10 BL - Train d'atterrissage	Carrello d'atterraggio: UMX A-10 BL
EFLU3706	Hatch/Canopy: UMX A-10 BL	Abdeckung/Kanzel: UMX A-10 BL	UMX A-10 BL - Trappe/Cockpit	Naca pilota/capottina: UMX A-10 BL
EFLU3707	Decal sheet: UMX A-10 BL	Decalsatz: UMX A-10 BL	UMX A-10 BL - Plaque de décoration	Decalcomanie: UMX A-10 BL
EFLU3708	Pushrod set: UMX A-10 BL	Schubstangensatz: UMX A-10 BL	UMX A-10 BL - Tringleries	Decalcomanie: UMX A-10 BL
SPM6836	Replacement Servo Mechanics: 2.3-Gram 2030L	Ersatz-Servotechnik: 2,3 Gramm 2030L	SA2030L -Mécanique de remplacement servo	Meccanica servo sostitutiva: 2,3 grammi 2030L
SPMSA2030L	2.3-Gram Performance Linear Long Throw Servo	2,3 g Performance-Linear servo mit langem Ruderweg	Servo linéaire course longue de 2,3g	Servocomandi lineari performance a corsa lunga da 2,3 g

**– Optional Parts and Accessories –**  
**– Optionale Bauteile und Zubehörteile –**  
**– Pièces optionnelles et accessoires –**  
**– Parti opzionali e accessori –**

Part # • Nummer Numéro • Codice	Description	Beschreibung	Description	Descrizione
EFLA230	Charger Lead with JST Female	E-flite Ladekabel m/ JST Buchse	Câble de charge avec prise JST femelle	Cavo di carica con femmina JST
DYNC2010CA	Prophet Sport Plus 50W AC/DC Charger	Prophet Sport Plus 50 W Wechsel-/ Gleichstrom-Ladegerät	Chargeur Prophet Sport Plus 50W AC/DC	Invertitore per servi lineari UM
EFLA111	Li-Po Cell Voltage Checker	Li-Po-Zelle Spannungsprüfer	Testeur de tension batterie Li-Po	Strumento controllo voltaggio celle LiPo
EFLA700UM	Charger Plug Adapter EFL	Ladegerät Zwischenstecker EFL	Ultramico adaptateur de charge EFL	Adattatore presa caricabatteria EFL
PKZ1039	Hook and Loop Set (5) Ultra Micros	Klettbandsatz (5) Ultra Micros	Set velcro Ultra Micros (5)	Set fascette fissaggio (5): Ultra Micros
EFLB4502SJ30	450mAh 2S 7.4V 30C Li-Po, 18AWG JST	450mAh 3S 7.4V 30C Li-Po, 18AWG JST Akku	Batterie Li-Po 7.4V 3S 450mA 30C, 18AWG JST	Batteria Li-Po450mAh 2S 7.4V 30C, 18AWG JST
EFLB4502SJ50	450mAh 2S 7.4V 50C Li-Po, 18AWG JST	450mAh 3S 7.4V 50C Li-Po, 18AWG JST Akku	Batterie Li-Po 7.4V 3S 450mA 50C, 18AWG JST	Batteria Li-Po450mAh 2S 7.4V 50C, 18AWG JST
EFLB8002SJ30	800mAh 2S 7.4V 30C Li-Po, 18AWG JST	800mAh 3S 7.4V 30C Li-Po, 18AWG JST Akku	Batterie Li-Po 7.4V 3S 800mA 30C, 18AWG JST	Batteria Li-Po 800mAh 2S 7.4V 30C, 18AWG JST
	DXe DSMX 4-Channel Transmitter	DXe DSMX 4-Kanal-Sender	Emetteur DXe DSMX 4 voies	DXe DSMX trasmittente 4 canali
	DX6e DSMX 6-Channel Transmitter	DX6e DSMX 6-Kanal Sender	Emetteur DX6e DSMX 6 voies	DX6e DSMX Trasmittitore 6 canali
	DX6 G2 DSMX 6-Channel Transmitter	DX6 G2 DSMX 6-Kanal Sender	Emetteur DX6 G2 DSMX 6 voies	DX6 G2 DSMX Trasmittitore 6 canali
	DX7 G2 DSMX 7-Channel Transmitter	Spektrum DX7 G2 7-Kanal-Sender	Emetteur DX7 G2 DSMX 7 voies	DX7 G2 DSMX trasmittente 7 canali
	DX8 G2 DSMX 8-Channel Transmitter	Spektrum DX8 G2 8-Kanal-Sender	Emetteur DX8 G2 DSMX 8 voies	DX8 G2 DSMX trasmittente 8 canali
	DX9 DSMX 9-Channel Transmitter	Spektrum DX9 9-Kanal-Sender	Emetteur DX9 DSMX 9 voies	DX9 DSMX trasmittente 9 canali
	DX18 DSMX Transmitter	Spektrum DX18 nur Sender	Emetteur DX18 DSMX 8 voies	DX18 DSMX Solo trasmittente
	DX20 DSMX Transmitter	Spektrum DX20 nur Sender	Emetteur DX20 DSMX 8 voies	DX20 DSMX Solo trasmittente



# UMX™ A-10

© 2016 Horizon Hobby, LLC.

E-flite, AS3X, UMX, DSM, DSM2, DSMX, ModelMatch, Bind-N-Fly, Celectra and the Horizon Hobby logo are trademarks or registered trademarks of Horizon Hobby, LLC.

The Spektrum trademark is used with permission of Bachmann Industries, Inc.

Futaba is a registered trademark of Futaba Denshi Kogyo Kabushiki Kaisha Corporation of Japan.

All other trademarks, service marks and logos are property of their respective owners.

US 7,898,130. US D578,146. PRC ZL 200720069025. PRC ZL 2007001249, US 8,672,726.

Other patents pending.

[www.e-fliterc.com](http://www.e-fliterc.com)